

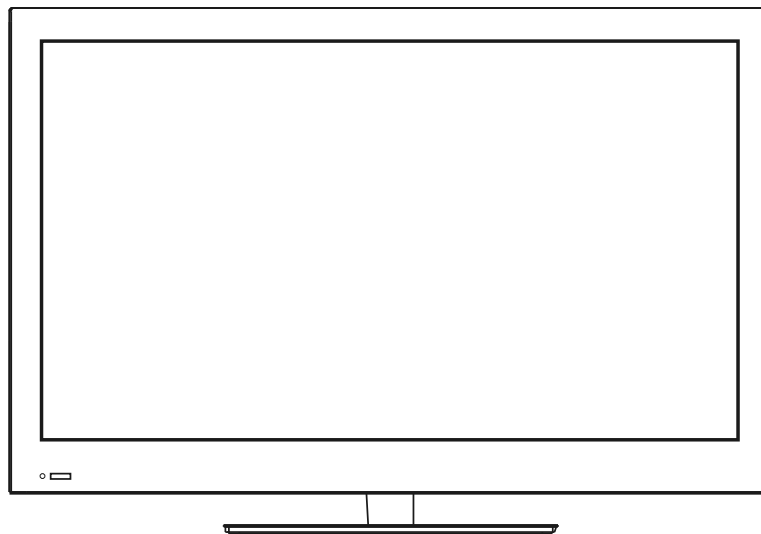

ELPCFT421 42" PDP Television

Owner's Manual



A PREMIUM DISPLAY PRODUCT

PART NO.

To activate your warranty, for product support and to see the full line of Element LCD TVs, visit www.elementelectronics.com

Table of contents

FCC Statement	2
Important safety instructions	3
Setting up	5
Base installation instruction	5
Locating TV buttons and connectors	6
Connection to other devices	8
Using the remote control	10
Identifying the remote control buttons	10
Brief operations of the remote control	11
Basic operation	11
Power on/off	11
Changing channels/volume	11
Select input source	11
Change picture mode	11
Change sound mode	12
Mute sound	12
Set sleep timer	12
Change view ratio	12
GUIDE	12
Changing the TV settings	13
Using the TV Menu	13
Using the Video Menu	14
Using the Audio Menu	15
Using the Setup Menu	16
Using the Parental Menu	18
Appendix	20
Specification	20
Trouble shooting	21
Accessories	21

Important to user

➤ FCC Statement

NOTE:

The manufacturer is not responsible for any radio or TV interference caused by unauthorized modifications to this equipment. Such modifications could void the user's authority.



NOTE:

This equipment has been tested and found to comply with the limits for a class B digital Device, pursuant to part 15 of the FCC Rules. These limits are designed to provide reasonable protection against harmful interference in a residential installation. This equipment generates, uses and can radiate radio frequency energy and, if not installed and used in accordance with the instructions, may cause harmful interference to radio Communications. However, there is no guarantee that interference will not occur in a particular installation. If this equipment does cause harmful interference to radio or television reception, which can be determined by turning the equipment off and on, the user is encouraged to try to correct the interference by one or more of the following measures:

1. Reorient or relocate the receiving antenna.
2. Increase the separation between the equipment and the receiver.
3. Connect the equipment into an outlet on a circuit different from that to which the receiver is connected.
4. Consult the dealer or an experienced radio/TV technician for help.

Important safety instructions

➤ Important safety instructions

	CAUTION RISK OF ELECTRIC SHOCK DO NOT OPEN	
CAUTION: TO REDUCE THE RISK OF ELECTRIC SHOCK, DO NOT REMOVE COVER(OR BACK).NO USER-SERVICEABLE PARTS INSIDE. REFER SERVICING TO QUALIFIED SERVICE PERSONNEL.		



The lightning flash with arrowhead symbol, within an equilateral triangle is intended to alert the user to the presence of uninsulated dangerous voltage within the product's enclosure that may be of sufficient magnitude to constitute a risk of electric shock.



The exclamation point within an equilateral triangle is intended to alert the user to the presence of important operating and maintenance(servicing) instructions in the literature accompanying the set.

CAUTION: CHANGES OR MODIFICATIONS NOT EXPRESSLY APPROVED BY THE PARTY RESPONSIBLE FOR COMPLIANCE WITH THE FCC RULES COULD VOID THE USERS AUTHORITY TO OPERATE THIS EQUIPMENT.

WARNING: TO PREVENT FIRE OR SHOCK HAZARD, DO NOT EXPOSE THIS APPLIANCE TO RAIN OR MOISTURE.

1. READ THESE INSTRUCTIONS
2. KEEP THESE INSTRUCTIONS
3. HEED ALL WARNINGS
4. FOLLOW ALL INSTRUCTIONS
5. DO NOT USE THIS APPARATUS NEAR WATER
6. CLEAN ONLY WITH DRY CLOTH
7. DO NOT BLOCK ANY VENTILATION OPENINGS
8. DO NOT INSTALL NEAR ANY HEAT SOURCES
9. DO NOT DEFEAT THE SAFETY PURPOSE OF THE POLARIZED OR GROUNDING-TYPE PLUG
10. PROTECT THE POWER CORD FROM BEING WALKED ON OR PINCHED PARTICULARLY AT PLUGS, CONVENIENCE RECEPTACLES, AND THE POINT WHERE THEY EXIT FROM THE APPARATUS.
11. ONLY USE ATTACHMENTS/ACCESSORIES SPECIFIED BY THE MANUFACTURE.
12. USE ONLY WITH CART, STAND, TRIPOD, BRACKET, OR TABLE SPECIFIED BY THE MANUFACTURER, OR SOLD WITH THE APPARATUS. WHEN A CART IS USED, USE CAUTION WHEN MOVING THE CART/APPARATUS COMBINATION TO AVOID INJURY FROM TIP-OVER.



S3126A

Important safety instructions

➤ Important safety instructions

13. **UNPLUG THIS APPARATUS DURING LIGHTNING STORMS OR WHEN UNUSED FOR LONG PERIODS OF TIME.**
14. **REFER ALL SERVICING TO QUALIFIED SERVICE PERSONNEL. SERVICING IS REQUIRED WHEN THE APPARATUS HAS BEEN DAMAGED IN ANY WAY, SUCH AS POWER-SUPPLY CORD OR PLUG IS DAMAGED, LIQUID HAS BEEN SPILLED OR OBJECTS HAVE FALLEN INTO THE APPARATUS, THE APPARATUS HAS BEEN EXPOSED TO RAIN OR MOISTURE, DOES NOT OPERATE NORMALLY, OR HAS BEEN DROPPED.**
15. **POWER SOURCE:** This TV should be operated only from the type of power source indicated on the marking label. If you are not sure of the type of power supply to your home, consult your appliance dealer or local power company. For TVs intended to operate from battery power, or other sources, refer to the operating instructions.
16. **POWER CORD PROTECTION:** Power-supply cords should be routed so that they are not likely to be walked on or pinched by items placed upon or against them, paying particular attention to cords at plugs, convenience receptacles, and the point where they exit from the appliance.

17. **OUTDOOR ANTENNA GROUNDING**

If an outside antenna or cable system is connected to the TV, be sure the antenna or cable system is grounded to provide some protection against voltage surges and built-up static charges. Section 810 of the National Electrical Code, ANSI/NFPA NO.70, provides information with respect to proper grounding of the mast and supporting structure, grounding of the lead-in wire to an antenna discharge unit, size of grounding conductors, location of antenna discharge unit, connection to grounding electrodes, and requirements for the grounding electrode. (Fig.A)

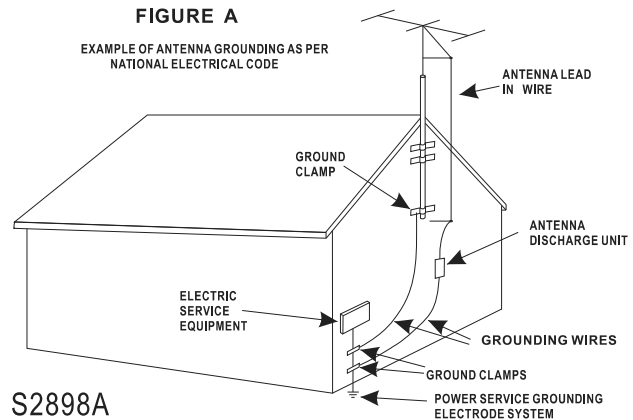

S2898A

18. **LIGHTNING:** For added protection for this TV receiver during a lightning storm, or when it is left unattended and unused for long periods of time, unplug it from the wall outlet and disconnect the antenna or cable system. This will prevent damage to the TV due to lightning and power line surges.
19. **POWER LINES:** An outside antenna system should not be located in the vicinity of overhead power lines, or other electric light or power circuits, or where it can fall into such power lines or circuits. When installing an outside antenna system, extreme care should be taken to keep from touching such power lines or circuits as contact with them might be fatal.
20. **OVERLOADING:** Do not overload wall outlets and extension cords as this can result in a risk of fire or electric shock.
21. **OBJECT AND LIQUID ENTRY:** Never push objects of any kind into this TV through openings as they may touch dangerous voltage points or short out parts that could result in fire or electric shock. Never spill liquid of any kind into the TV.
22. **SERVICING:** Do not attempt to service this TV yourself as opening or removing covers may expose you to dangerous voltage or other hazards. Refer all servicing to qualified service personnel.
23. **REPLACEMENT PARTS:** When replacement parts are required, be sure the service technician uses replacement parts specified by the manufacturer that have the same characteristics as the original part. Unauthorized substitutions may result in fire, electric shock, injury to persons or other hazards.
24. **SAFETY CHECK:** Upon completion of any service or repairs to this TV, ask the service technician to perform routine safety checks to determine that the TV is in proper operating condition.
25. The apparatus shall not be exposed to dripping or splashing and no objects filled with liquids such as vase, shall be placed on the apparatus.
26. **WARNING:** Plug the power cord into a power outlet where access to the power cord connector is readily accessible in case power dis-connection is required.
27. **ATTENTION:** This device complies with Part 15 of the FCC Rules. Operation is subject to the following two conditions: (1) this device may not cause harmful interference, and (2) this device must accept any interference received, including interference that may cause undesired operation.
28. **CAUTION:** To reduce the risk of electric shock, grounding of center pin of this plug must be maintained.
29. **WARNING:** Plug the power cord into a power outlet where access to the power cord connector is readily accessible, in case if the power needs to be immediately disconnected.
30. **ATTENTION:** This device complies with Part 15 of the FCC Rules. Operation is subject to the following two conditions: (1) this device may not cause harmful interference, and (2) this device must accept any interference received, including interference that may cause undesired operation.
 - a). **Disposal of packaging:** The packaging of this product is intended to be recycled. Apply to the local authorities for correct disposal.
 - b). **Disposal of batteries:** The batteries supplied do not contain the heavy metals mercury and cadmium. Please check on how to dispose exhausted batteries according to local regulations.
 - c). **Note Specifications and information** are subject to change without notice. If you need further assistance, please call the customer support service in your country.
31. **POWER-CORD INSERT CHECK:** When connecting the power cord to the connector of the TV, make sure the power cord is fully inserted in the place. Bad contact may cause high temperature of the connector and the risk of fire or other damages.

Setting up

➤ Base Installation Instructions

1. Lay a cloth or other soft material on a flat table to avoid damage to the PDP screen.
2. Put the TV back upward and the PDP screen downward and keep it flat on the surface.
3. Take out the base and insert it into the installing slot in the lower part of the TV until all of the holes match each other.
4. Fasten the base and the TV set together with the 4 screws provided.
5. Erect the TV set, and put it on the proper position for watching.

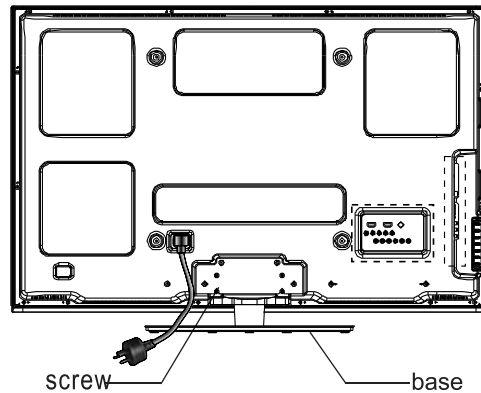
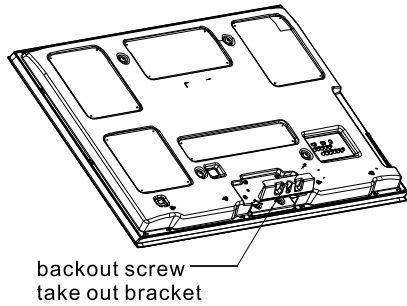

Note:

The above figures are for reference only, please refer to the actual units to determine the appearances.
Every hole of the base must be fastened with screws!

Setting up

➤ Locating TV buttons and connectors

Note: The below figures are for reference only, please refer to the actual units to determine the appearance.

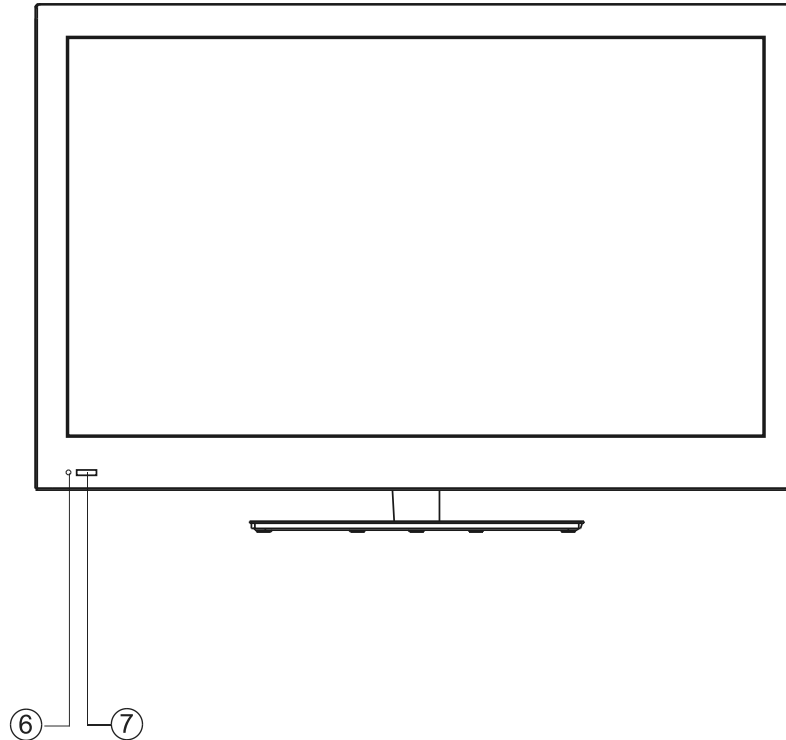

NO.	TV(front)	Description
1	MENU	Display the onscreen display(OSD) or Exit to close the OSD.
2	INPUT	Select the input source. Press INPUT to open the list of input sources.
3	VOL▲/VOL▼	Raise or lower the sound level. In an OSD menu, press these buttons to move right or left in the menu or to adjust an item.
4	CH▲/CH▼	Select the next higher or lower channel. In an OSD menu, press these buttons to move up or down in the menu.
5	⏻ (Standby)	Press to turn your TV on or off (standby mode).
6	Remote control sensor	Receives signals from the remote control. Please do not block.
7	Power indicator	The light shows whether the TV is on or standby mode.

Setting up

➤ Locating TV buttons and connectors

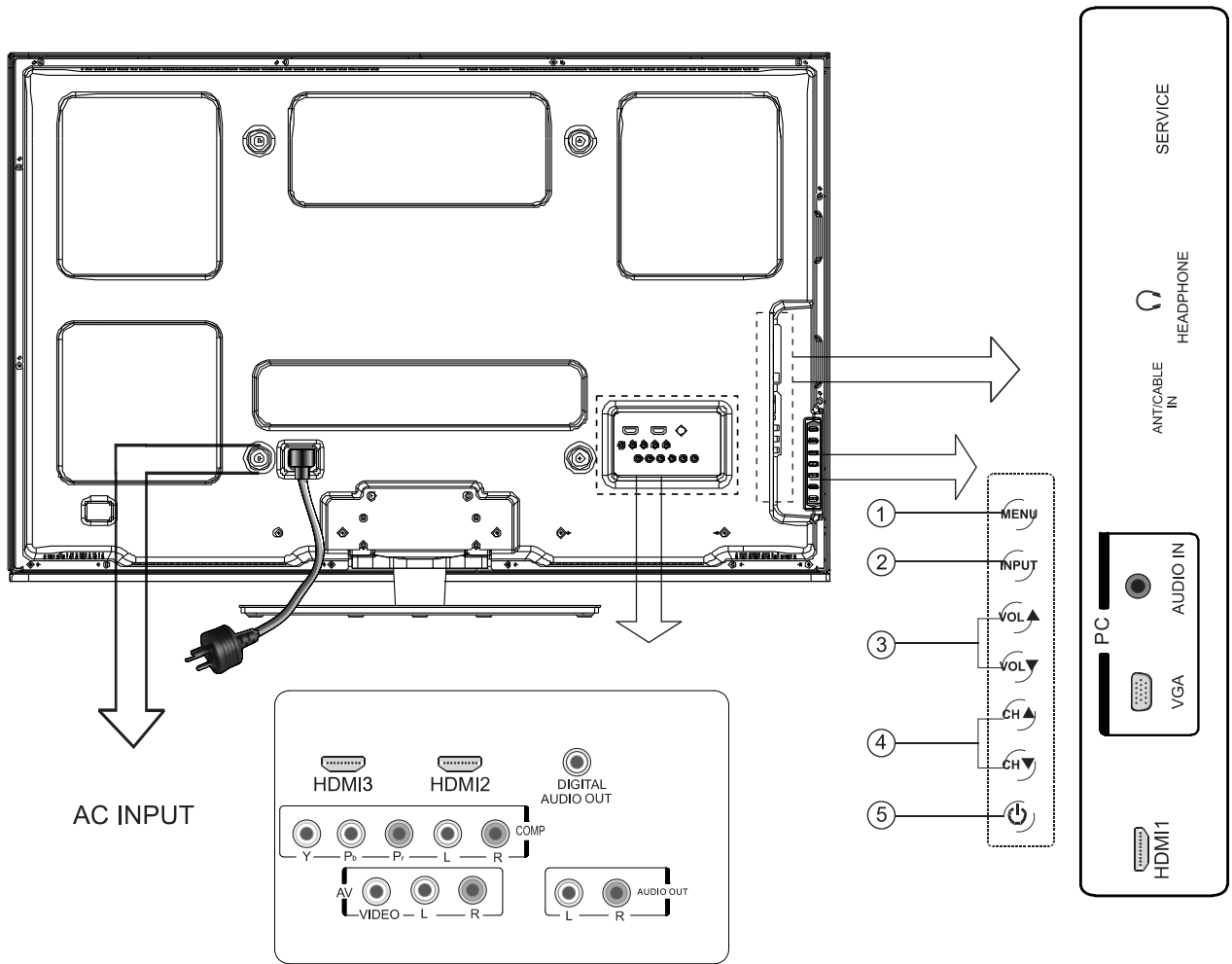

Setting up

➤ Connect to other devices

Warning: Before connecting the TV to any other electronic device, unplug the TV and electronic device AC cords from the AC Input.

Not all following terminals are included on your TV. Please refer to the "Locating TV buttons and connectors" to determine which inputs are available on your TV.

1. Connect to a broadcast antenna or cable TV

For optimal picture quality, it is strongly recommended to have an external antenna or a cable TV.

Note:

- It is recommended that coaxial cable (75Ω) be used to eliminate the interference caused by the mismatched impedance.
- The antenna cable should not be bound together with the power cord.
- When using the cable TV, please insert the plug of the coaxial cable (75Ω) directly into the antenna outlet.

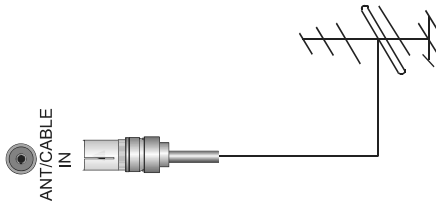

2. Connect to AV devices

- Connect a Video RCA cable to your TV set and the other ends to an appropriate external A/V device such as a VCR, DVD or Set-top boxes.
- Connect RCA audio cables to "R - L(audio)" on your TV set and the other ends to corresponding audio out connectors on the A/V device.

Video in (composite video) transmits video as a single signal.

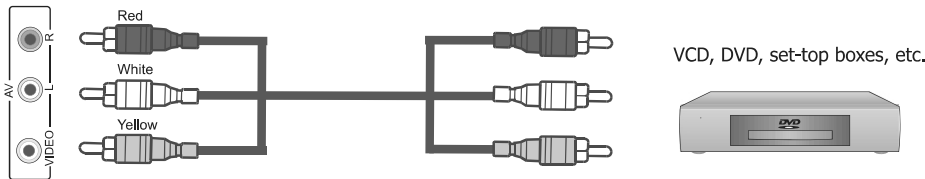

3. Connect to devices with Component interface

Component video (Y, Pb, Pr) transmits video as separate Y, Pb, Pr signals. Use this connection for high-definition video signals from a DVD or other equipment.

- Connect Component video and audio cables to Component inputs ("PR/CR", "PB/CB", "Y") on the rear of your TV set and the other ends to corresponding component video out connectors on the PVR or DVD.
- The Y, PB/CB and PR/CR" connectors on your component devices (PVR or DVD) are sometimes labeled Y, B-Y and R-Y or Y, CB and CR. (Colors for inputs and cables must correspond on both devices.)

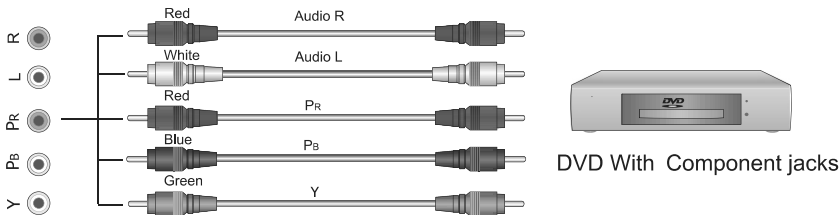

4. Connect to devices with HDMI interface

HDMI transmits an all-digital signal and is the recommended choice for playback from a digital DVD or DVR. No sound connection is needed for HDMI to HDMI connection.

- HDMI cable connected to the HDMI connector on the TV.

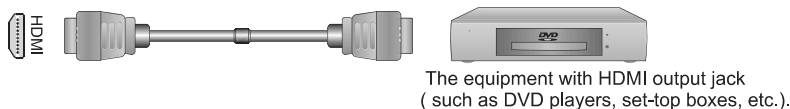

Setting up

➤ Connect to other devices

5. Connect to PC

- Connect the D-Sub cable to "VGA" on the rear of your TV set and the other end to the Video Card of your computer.
- Connect the stereo audio cable to "PC AUDIO" on the rear of your TV set and the other end to "Audio Out" of the sound card on your computer.

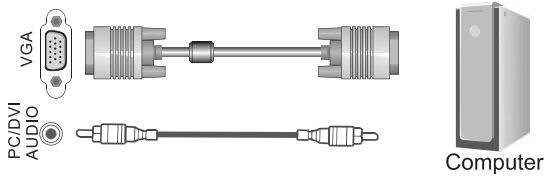

6. Connect to headphone

- Connect the headphone jack of the TV set.
- The volume of the headphone is automatically adjusted with the main volume of the TV set.

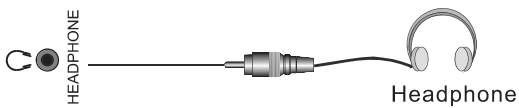

7. Digital audio

Connect an digital audio device to this jack (Coaxial cable is needed).
Note: DTV and HDMI output only.

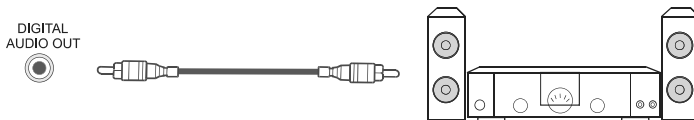

Using the remote control

➤ Identifying the remote control buttons

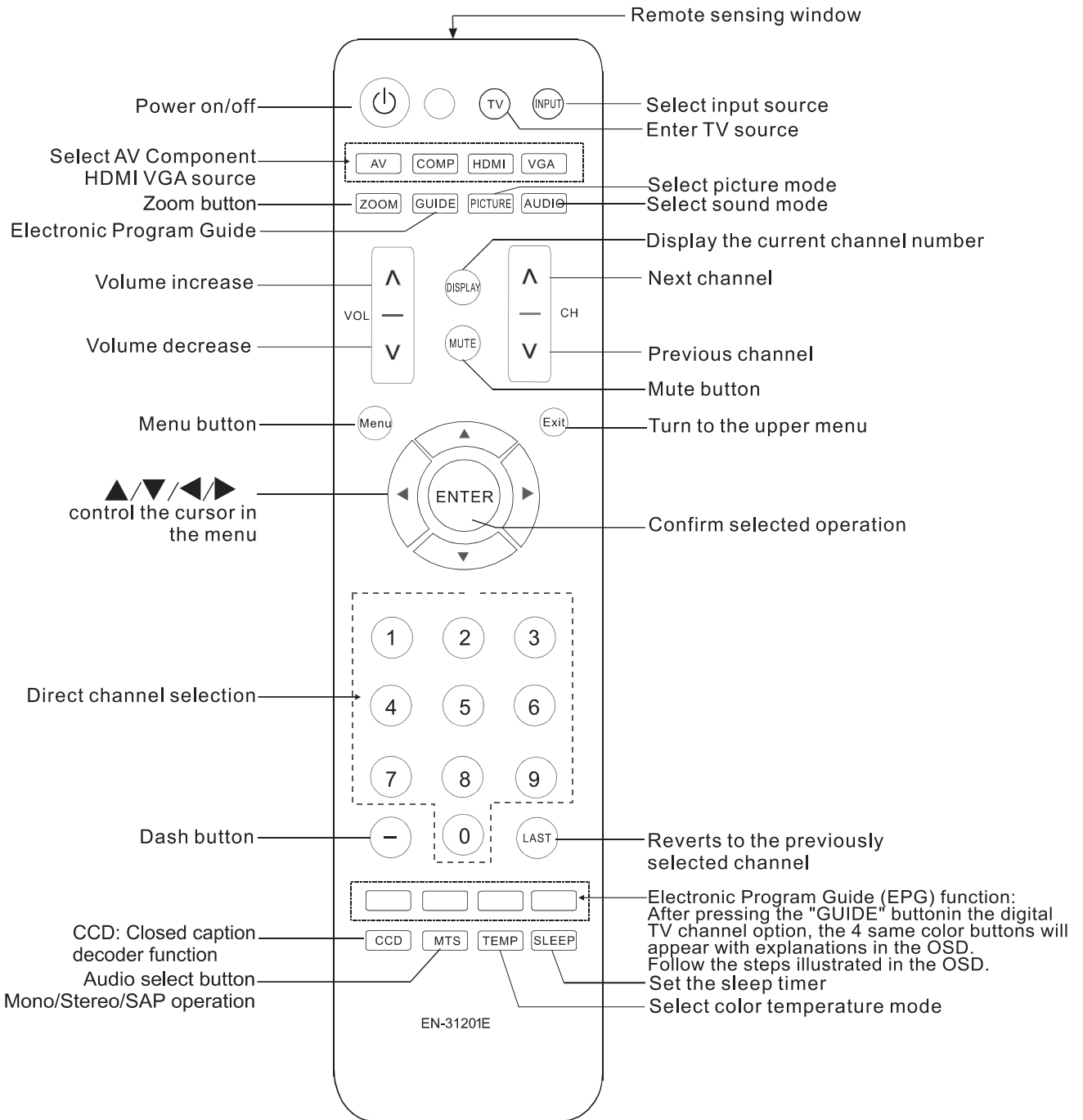

Using the remote control

➤ Brief operations of remote control

Change the batteries

1. Open the battery cover on the back of the remote control.
2. Install two AAA size (1.5V) batteries. Match the "+" and "-" signs on the batteries to the signs on the battery compartment.
3. Close the battery cover.

Note:

1. Dispose of your batteries in a designated disposal area. Do not throw batteries into a fire.
2. Do not mix battery types or combine used batteries with new ones.
3. Remove dead batteries immediately to prevent batter acid from leaking into the battery compartment.
4. If you do not use the remote control for a long time, remove the batteries.

The effective range of remote control

1. The remote control distance: 315inches in front of the TV set.
2. The remote control angle: taking the television infrared light receiver window as an apex, 236inches away, its controlled angle (left to right) is within 30 degrees, while the vertical angle (up to down)is within 30 degrees.

Basic operations

➤ Power on/off

1. Connect the Power Cord to the connector on the back of the TV. When connecting the power cord to the connector of the TV, make sure the power cord is fully inserted in its place. Bad contact may cause high temperature of the connector and the risk of fire or other damages
- 2.Connect the TV power cord to AC outlet.
3. Press the Power button on the TV set. When the TV is on, press the Power button on the remote control, and the TV will enter Standby state. Press this button again, and you can watch TV normally.
4. Press the Power button again to turn off the TV.

➤ Changing Channels/ Volume

1. Press [CH^ / V] button on the remote control, you can change the channels.
(Press [VOL^ / V]button to raise or lower the volume).
2. Press [CH▲/▼]button on the side of TV set panel of the TV set, you can also change the channels.
(Press [VOL▲/▼] button to raise or lower the volume).
3. Press the numeric buttons on the remote control to display the corresponding channels.

Note:

Changing the channels can also be achieved by directly pressing the programme No. If you want to choose the programme No. from 1 to 9, press the numeric buttons directly. If you want to select a programme No. that double-digit or three-figure, the time between twice pressing the numbers should not be more than 3 seconds.

➤ Select input source

Choose the current input signal of the main picture. You can press the TV AV COMP HDMI VGA button to choose the source you want or press [INPUT] button to display the signal inputs. Press [▲/▼]button to select the source you wanted to enter, then press [▶/ENTER] button to confirm. You can also press the [INPUT] button continuously to choose the source you want.

➤ Change picture mode

It can be set as Standard, Cinema, User and Vivid. This mode achieves a certain image display effect by setting the brightness, contrast and color etc.

Basic operations

➤ **Change sound mode**

It can be set as Standard, Speech, User and Music.

➤ **Mute sound**

Press [Mute] button to turn the sound off, press this button again to turn the sound back on. This function is used to switch off sound temporarily.

➤ **Set sleep timer**

It can set the TV to let it enter into the Standby state automatically, Press this button repeatedly to select the proper sleeping clock mode, and the clock tells you the remaining time before the TV enters Standby state.

➤ **Change view ratio**

Press the [ASPECT] button to select from five zoom modes: Wide, Normal, Zoom, Cinema, Dot-to-Dot.

Note: The option of zoom mode is different in different sources

➤ **GUIDE**

GUIDE: Electronic progra Guide, you can see the progra information.

Changing the TV settings

➤ Using the TV Menu

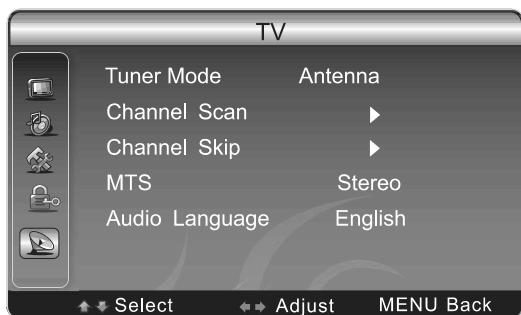

- 1 Press the Menu button to display the main menu.
- 2 Press [▲▼] button to select TV item.
- 3 Press [▶/ENTER] button to enter TV menu.
- 4 Press [▲▼] button to select the option, press [▶/ENTER] button to enter or press [◀/Exit] button to exit.
- 5 When you are finished, press the Menu button to close the menu.

You can adjust:

- **Tuner Mode** – Select the TV signal source. You can select Antenna or Cable.
- **Channel Scan** – Scans for channels that have signals and stores the channels information in memory.
DTV: The scanned TV program in digital signals.
TV: The scanned program in analog signals.
- **Channel Skip** – Deletes a channel stored in memory. When you press CH▲ or CH▼, your TV skips the channel you deleted. You can still tune to the channel using the number buttons on the remote control.
- **MTS** – Selects the sound mode. You can select Mono, Stereo, or SAP (Second Audio Program).
- **Audio Language** – Selects the audio language for a program.
SAP (Second Audio Program) – Depending on the particular program being broadcast, you can listen to a foreign-language translation.

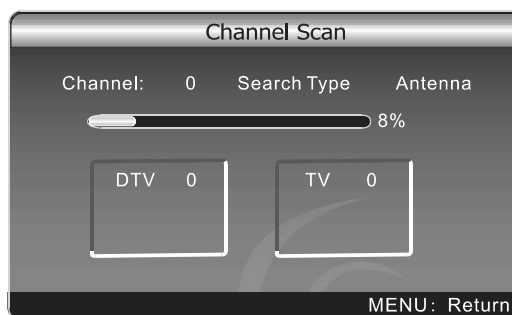

Changing the TV settings

➤ Using the Video Menu

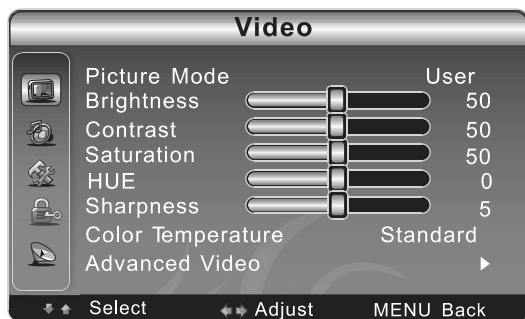

- 1 Press Menu button to display the main menu.
- 2 Press [▲▼] button to select Video item.
- 3 Press [▶/ENTER] button to enter Video menu.
- 4 Press [▲▼] button to select the option, press [▶/ENTER] button to enter or press [◀/Exit] button to exit.
- 5 When you are finished, press the Menu button to close the menu.

You can adjust:

- **Picture Mode** – Adjusts the Picture Mode. You can select Standard, Cinema, User or Vivid.
 - **Brightness** – You can increase or decrease the brightness of the picture. Increasing the brightness can add more light to dark areas of the picture, while decreasing the brightness can add more darkness to light areas of the picture.
 - **Contrast** – You can increase or decrease the contrast of the picture. Increase the contrast to adjust the white areas of the picture or decrease the contrast to adjust the black areas of the picture.
 - **Saturation** – Adjusts the intensity of the colors.
 - **Hue** – Adjust the overall color of the picture.
 - **Sharpness** – You can increase the sharpness level for clearer images or decrease the sharpness level for smoother images.
 - **Color temperature** – Changes the color temperature. You can select the color temperature from three options: Cool, Standard or Warm.
 - **Advanced Video** – Accesses advanced video settings such as DNR, Adaptive Luma Control and Flesh Tone.
- ◇ **DNR**: Select to reduce the noise level of connected equipment: Off/Low/Standard/ and strong.
 - ◇ **Adaptive Luma Control**: According to the content of picture, it can adjust brightness automatically.
 - ◇ **Flesh Tone**: When this feature is "on" state, the TV could be the basis of image content, for color correction.



Changing the TV settings

➤ Using the Audio Menu

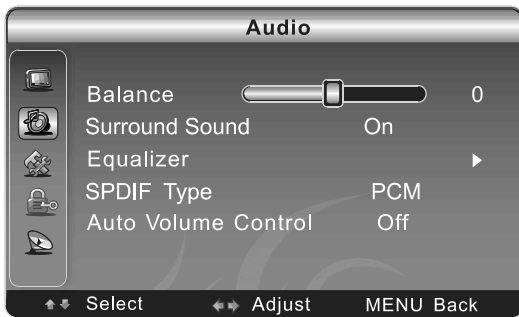

- 1 Press Menu button to display the main menu.
- 2 Press [▲▼] button to select Audio item.
- 3 Press [▶/ENTER] button to enter Audio menu.
- 4 Press [▲▼] button to select the option, press [▶/ENTER] button to enter or press [◀/Exit] button to exit.
- 5 When you are finished, press the Menu button to close the menu.

You can adjust:

- Balance – Adjusts the volume of the left and right speakers.
- Surround Sound – Turns the surround sound effect on or off.
- Equalizer – Weaken or enlarge the sound of the main frequency points.
- SPDIF Type – Selects the SPDIF type. You can select PCM, Dolby Digital or Off.

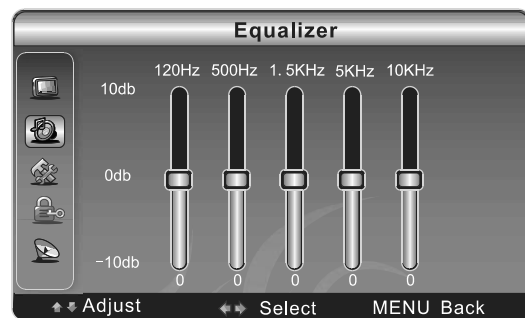

PCM - PCM is an encoding, mainly used for analog signal, Dolby mainly used for digital signal.

Dolby - when the data stream carries Dolby signal, digital SPDIF outputs Dolby data stream.

When the data stream carries no Dolby signal, it transports PCM data stream.

- Auto Volume Control – Adjust volume according to different audio signal.

Note: Via SPDIF Type, you can choose the digital audio out type. If Auto Volume Control is On, that means audio out control is activated.

Changing the TV settings

➤ Using the Setup Menu

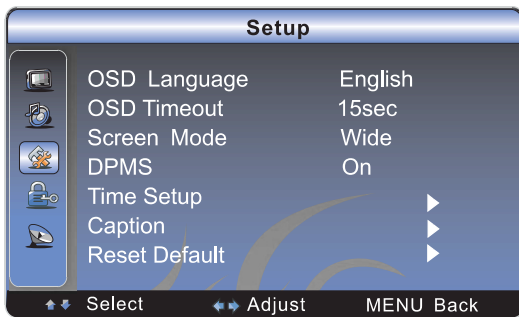

- 1 Press Menu button to display the main menu.
- 2 Press [▲/▼] button to select Setup item.
- 3 Press [▶/ENTER] button to enter Setup menu.
- 4 Press [▲/▼] button to select the option, press [▶/ENTER] button to enter or press [◀/Exit] button to exit.
- 5 When you are finished, press the Menu button to close the menu.

You can adjust:

- OSD Language – Use the right or left arrow button to choose the OSD Language among English, Spanish and French.
- Screen Mode – Use the arrow button to choose the screen aspect ration from Wide, Normal, Zoom, Cinema, Panorama, Dot-to-Dot or Auto.

1 Normal

The original 4:3 aspect ratio (1.33:1 signal) is preserved, so black bars are added to the left and right of the image. Standard TV broadcasts are displayed with a 4:3 aspect ratio.

2 Wide

When watching a standard broadcast or full-frame movie in this mode, the display image is stretched proportionately to fill the TV screen. When watching a widescreen (1.78:1 signal) program or movie, the display image fills the TV screen.

3 Zoom

Stretches the 4:3 aspect ratio image vertically and horizontally to fill the screen at 1:1.78 aspect ratio.

4 Cinema

Stretches the 4:3 aspect ratio image vertically and horizontally to fill the screen at 1:2.35 aspect ratio.

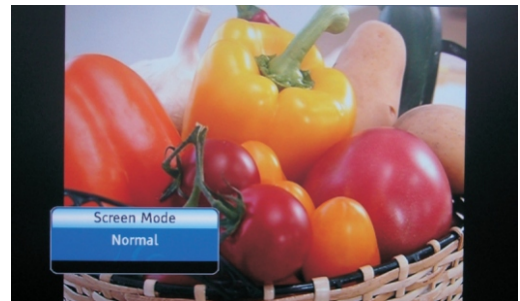

Changing the TV settings

➤ Using the Setup Menu

- 5 Dot to dot
Use the function to see the full image without any cutoff, when HDMI, Component, DTV, VGA or AV signals are inputs.



- DPMS – This is a good function for a computer monitor. When DPMS is on, the computer will control the screen on or off. For example, if the computer is in sleep mode, the screen will be switched off. If the computer is activated, the screen also is activated.
- Time Setup – You can set up the exact time by yourself. You can also set up Sleeper Time and Auto Sleep Time.

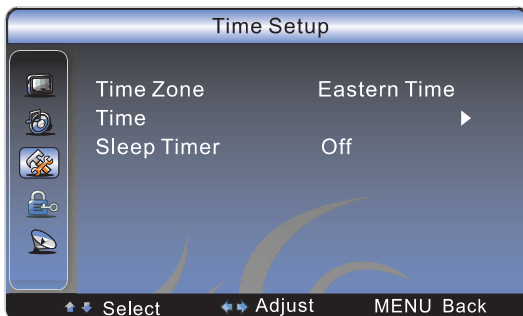

- Caption: There are three items in it – Analog Closed Caption, Digital Closed Caption and Digital Caption Style. This is a function about caption, display caption by analog signal and display caption by digital signal.

Analog Closed Caption: CC1, CC2, CC3, Cc4,
TEXT1, TEXT2, TEXT3, TEXT4.

Digital Closed Caption: Service1, Service2, Service3,
Service4, Service5, Service6.

Digital Caption Style: There are two Caption Styles. One is the automatic function set as the broadcaster, while the other is the custom style where you can adjust the font size, color, opacity, background color etc., accordingly.

- Reset Default – Every TV has its original setting before leaving the factory. So this function helps you restore these settings.

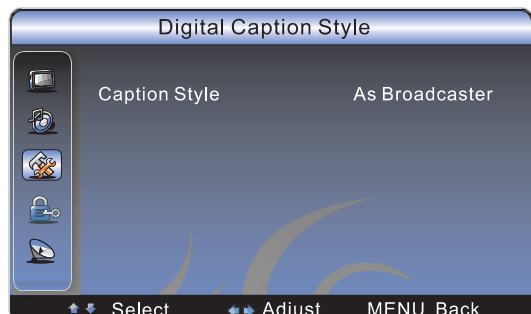
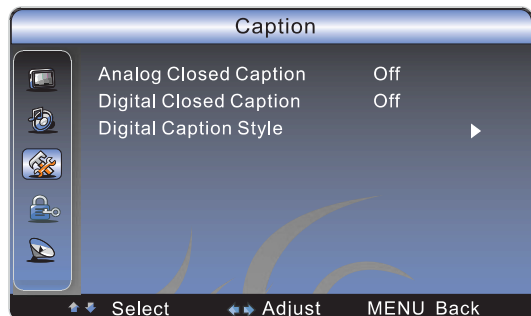

Changing the TV settings

➤ Using the Parental Menu

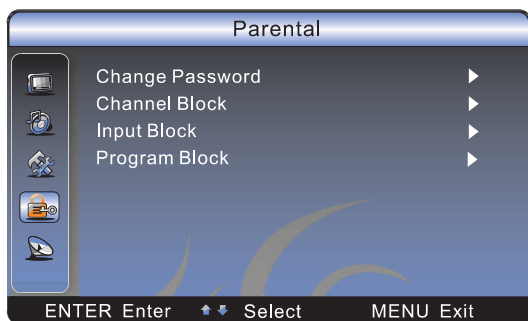

- 1 Press Menu button to display the main menu.
- 2 Press [▲▼] button to select Setup item.
- 3 Press [▶/ENTER] button to enter Setup menu.
- 4 Press [▲▼] button to select the option, press [▶/ENTER] button to enter or press [◀/Exit] button to exit.
- 5 When you are finished, press the Menu button to close the menu.

When you first use this function, the default password is [0000]. Once you input this password, you can: Press [▲▼] to highlight an option, then press [◀/▶] to adjust the option. You can adjust:

- Change Password – The first time you use this function, use the default password. If you want to change it, first enter the new password then enter the same password again.
- Channel Block – This function will let you block any channel you want.
- Input Block – You can block the input source with this function. For example, if you want to block AV input, just highlight [AV] and press [ENTER]. The AV input will not be seen in the screen.
- Clean All – This function will let you clean all the channels stored on this TV.

Note: If you choose this function, all the programs you preset will be lost.

- Program Block–
 - A. Rating Enable is on.
 - B. U. S. TV Ratings: You can choose TV ratings according to the illustration on the screen.
 - C. The settings for U. S. Movie Ratings, Canada (English) Ratings and Canada (French) Ratings follow Step B.
 If you want to block the unrated program, please turn on this function.

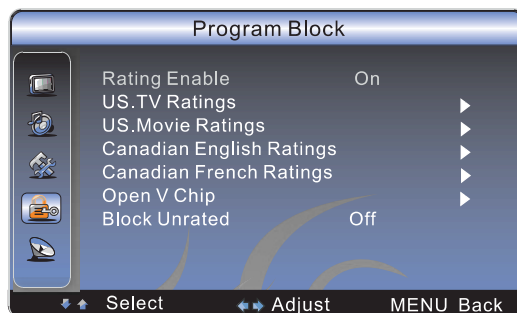
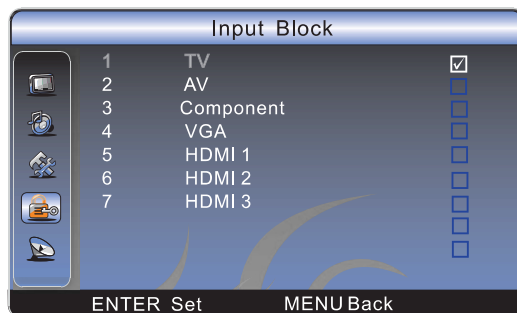
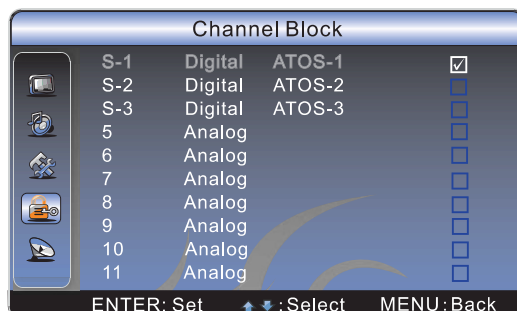

Changing the TV settings

➤ Using the Parental Menu

Following is the description of these ratings.

Age	Defined as
TV-Y	All children
TV-Y7	Directed to older children
TV-G	General audience
TV-PG	Parental Guidance suggested
TV-14	Parents Strongly cautioned
TV-MA	Mature Audience only

Contents	Defined as
FV	Fantasy Violence
D	Suggestive dialogue
L	Strong language
S	Sexual situations
V	Violence

Rating	Defined as
G	General audience
PG	Parental Guidance suggested
PG-13	Parents strongly cautioned
R	Restricted
NC-17	No one 17 and under admitted
X	Adult audience only

About Canada (French)

Rating	Description
G	General
8 ans+	8+General; Not recommended for young children
13 ans+	Programming may not be suitable for children under the age of 13
16 ans+	Programming is not be suitable for children under the age of 16
18 ans+	Programming restricted to adults

About Canada (English)

Rating	Description
C	Children
C8+	Children eight years and older
G	General Programming, suitable for all audiences
PG	Parents Guidance
14+	Viewers 14 years and older
18+	Adult programming

NOTE: As you block rating, all rating higher than the ones you select are blocked as well. For example, if you choose to block the MPAA rating R, the higher ratings, NC-17 and X, are automatically blocked too.

Appendix

➤ Specification

Model Name		ELPCFT421	
Dimension (W×H×D)(mm)	Without stand	1024.6 × 667.4×70	
	With stand	1024.6 × 711.6×260	
Weight(kg)	Without stand	19	
	With stand	21.5	
LCD Panel		106	
Minimum size (diagonal)		1024 × 768	
Screen resolution		1024 × 768	
Power consumption		209W	
Audio power		8W+8W	
Power supply		Refer to rating label	
Receiving systems	RF	NTSC/ATSC	
	AV	NTSC	
Component Input		480I/60Hz、480P/60Hz、 720P/60Hz、1080I/60Hz 1080P/60Hz	
VGA Input		VGA (640×480 60Hz) 、SVGA (800×600 60Hz) VGA (1024×768 60Hz)	
HDMI Input		RGB/60Hz (640×480、800×600、1024×768) YUV/60Hz (480I、480P、720P、1080I、1080P)	

Appendix

➤ Troubleshooting

When there is something wrong with your TV, you can try turning off the TV and then restart it. You can also operate according to the following chart. If the problem still cannot be solved, please contact the professional technicians.

No sound or picture	<ol style="list-style-type: none"> 1. Check if the power line is in the outlet and if it has electricity. 2. Check if you have pressed Power button on the TV or Power button on the remote control. 3. Check the setting of picture brightness and contrast. 4. Check the volume.
The picture is normal but there is no sound	<ol style="list-style-type: none"> 1. Check the volume. 2. Check if Mute mode is set.
No picture and white or black picture	<ol style="list-style-type: none"> 1. Adjust Picture Setting. 2. Check Color System.
The sound and picture are interfered	<ol style="list-style-type: none"> 1. Try to find the appliance affecting TV set, and move it far away from the TV set. 2. Try to insert the power plug of the TV set into another outlet.
Unclear picture or picture with snow	<ol style="list-style-type: none"> 1. Check the direction, position and connection of your antenna. 2. Adjust the direction of your antenna or reset or fine tune the channel.
The remote control does not work	<ol style="list-style-type: none"> 1. Change the batteries in the remote control. 2. Clean the upper side of the remote control (radiating window) 3. Check the contacting points of the batteries. 4. Check if there is obstruction between the remote control and the monitor. 5. Check if the batteries are correctly installed.
H/V strip or the picture shaking	Check if there is an interfering source nearby, such as appliance or electric tools.
The cabinet of the TV makes "Click" sound	makes "Click" sound"Sometimes the room temperature change can cause the television cabinet to inflate or contra, which makes this sound. This does not mean the TV breaks down.

➤ Accessories

Remote control.....	1
User's Manual.....	1
Dry Cell Battery.....	2
Power Cord.....	1
Screws for fix pedestal.....	4



This product contains electrical or electronic materials. The presence of these materials may, if not disposed of properly, have potential adverse effects on the environment and human health. Presence of this label on the product means it should not be disposed of as unsorted waste and must be collected separately. As a consumer, you are responsible for ensuring that this product is disposed of properly. To find out how to properly dispose of this product, please go to www.elementelectronics.com and click on Sustainability.

HDMI™

This TV incorporates High-Definition Multimedia Interface (HDMI™) technology. HDMI, the HDMI logo and High-Definition Multimedia Interface are trademarks or registered trademarks of HDMI Licensing LLC.